

MADE IN GERMANY



ELEKTROKONTAKT

Fascinating Electrotechnics



mYnitron®

very compact control unit series

8-9-0

tactile
robust
elegant



Front dimensions: \varnothing 23.5 mm
Panel cut-out: \varnothing 16.2 mm
Front bezel height: 4 mm



 Product configurator



mYnitron® - tactile, robust, elegant

Thanks to its very compact shape the new series mYnitron is ideal for applications with less space. It is designed not only for the classic use in the plant and machine engineering, but also for mobile operating units or small devices. The mYnitron pushbuttons not only convince by their flat shape and the very low mounting depth, but also by a pleasant switching feel and the appealing design. Beside the very short operating travel, particular importance was attached to the tactile feeling by a clear perceptible switching point of the pushbutton.

A real new feature in the mYnitron series is the active/inactive emergency-stop acc. to the actual standard EN ISO 13850:2015. The standard allows to indicate the status of an emergency-stop by a corresponding illumination. The mushroom of the active/inactive mYnitron emergency-stop is only illuminated in red in the status of functional operation, otherwise it is colourless and can no longer be recognised as emergency-stop. This makes it easy to identify inactive plant parts or deactivated operating units and thus it considerably improves the safety against a wrong operation in case of an emergency.

- no space problem - mounting depth only 18.0 mm
- panel cut-out Ø 16.2 mm
- good perceptible switching point
- degree of protection IP65 and IP67
- illuminated active/inactive and foolproof emergency-stop acc. to IEC 60 947-5-5



- | | |
|---|---------|
| 01 Pushbutton Heads | page 10 |
| 02 Emergency-Stop Buttons | page 13 |
| 03 Emergency-Stop Buttons active/inactive | page 12 |

Housing Colour



Mounting Depth Dimensions

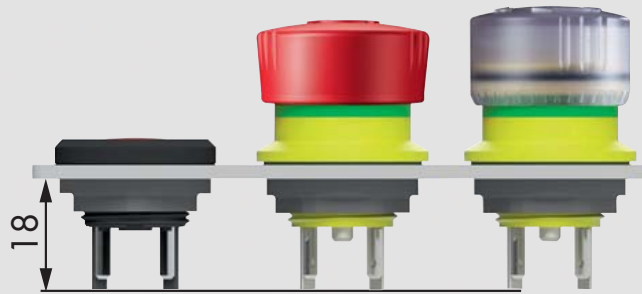

Cutout Dimensions

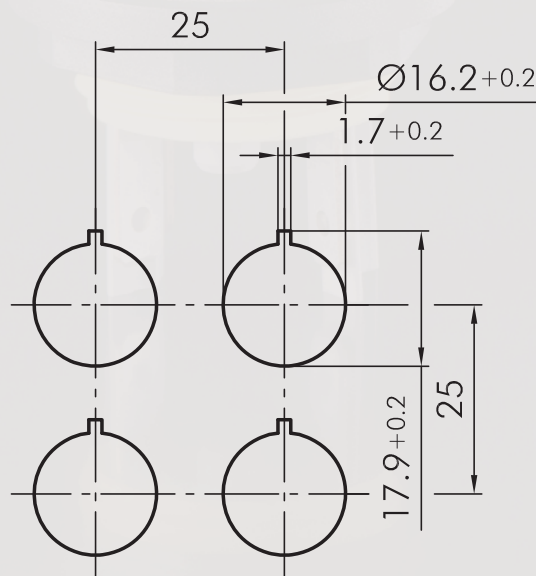

General Data

Type reference:	Y(M)T(L)(G)(x)(L_yyyy)(zzzzzz_zz)
Description:	Short-stroke pushbutton mYnitron
Approvals:	CE, cURus
Contact type:	1NO
Degree of protection:	IP65 / IP67
Operation travel:	1,0 mm
Connection type:	Faston terminals 2.8 mm x 0.5 mm
Contact material:	snap disk: stainless steel 1.4310 gold-plat. counter contact: CuZn37, gold-plat.
Max. storage temperature:	-40°C ... 80°C
Max. operating temperature:	-25°C ... 70°C
Mechanical life:	500,000 switching cycles
Electrical life (rated load):	500,000 switching cycles at rated load
Contact resistance NO:	< 100 mOhm
Min. current:	10 µA
Min. voltage:	20 mV
Bouncing time NO:	< 5ms

Electrical data acc. to IEC/EN 60947-5-1 (VDE 0660 Sect. 200)

	alternate current	direct current
Utilisation category:	AC12	DC12
Rated insulation voltage Ui:	42 V	42 V
Rated operating voltage Ue:	35 V	35 V
Rated operating current Ie:	100 mA	100 mA
Breaking capacity:	1 W (ohmic load)	1 W (ohmic load)
Continuous thermal current:	100mA	100mA

Technical Data - Lamp

Lamp socket:	none, with integrated LED
Max. lamp voltage:	10...32V
Max. lamp output:	20 mA (18...22 mA)
Definition:	+ ...anode, - ...cathode

Additional Data

Mounting aperture:	16.2 mm
Tightening torque (mounting nut):	max. 0.7 Nm
Mounting grid:	25mm x 25mm
Mounting position:	any
Standards:	IEC/EN 60947-5-1
Overtoltage category:	II
Pollution degree :	2

Electrical Features

B10:	600.000
------	---------

Note

Type Variants:	
Y(M)T(L)(G)(x)(L_yyyy)(zzzzzz_zz)	
(M)	... front ring titanium lacquered
(L)	... with illuminating option, LED
(G)	... non-transparent lens
(x)	... available lens colours x = {R...red, Y...yellow, B...blue, G...green, W...white, S...black}
(L_yyyy)	... printed with standard symbol
(zzzzzz_zz)	...customised printing

- Use partially insulated Faston terminals!
Recommended Schlegel type: "FHTI2,8x0.5_01"
0.5-1.5mm² (AWG 20-16)
-30°C - 75°C

- The max. tightening torque mounting nut to be observed (0.7 Nm) !

Data acc. to UL 60947-5-1

Ratings:	max. 30 Vac or 42.4 V peak, 100 mA, Class 2
Illumination:	10-32V DC 20 mA

Remark

For Class 2 Power Source or Limited Voltage / Limited Current only

About Us

Control Units
→ Actuators

Panel Mount Jacks

Bus Technology

RFID

Enclosures

Pedal/Limit Switches

Terminal Blocks

Type Index

General Data

Type reference:	YV(O)(OO)(H)(OOI)(LOO)(LO)(_AU)(_RO)(_674)
Description:	Emergency-stop Head, foolproof
Approvals:	CE, TÜV_Süd, UR
Contact type:	2NC / 2NC+1NO / 1NC
Degree of protection:	IP65 / IP67 / IP69K
Connection type:	Faston terminals 2.8 mm x 0.5 mm / soldering lug
Contact material:	AgNi / AgNi, gold-plated 5µm
Max. storage temperature:	-40°C ... 80°C
Max. operating temperature:	-25°C ... 70°C
Mechanical life:	30,000
Electrical life (rated load):	30,000 at rated load
Contact resistance NO:	< 20 mOhm / < 50 mOhm (Au)
Contact resistance NC:	< 20 mOhm / < 50 mOhm (Au)
Bouncing time NO:	< 10 ms
Bouncing time NC:	< 10ms
Positive opening contact:	acc. to EN60947-5-1, appendix K

Electrical data acc. to IEC/EN 60947-5-1 (VDE 0660 Sect. 200)

	alternate current	direct current
Utilisation category:	AC15	DC13
Rated insulation voltage Ui:	250 V	250V
Rated operating voltage Ue:	35 V	35 V
Rated operating current Ie:	5A	2 A
Breaking capacity:	10Ie	1,1Ie
Continuous thermal current:	5A	

Technical Data - Lamp

Lamp socket:	none, with integrated LED
Max. lamp voltage:	30 V AC/DC
Max. lamp output:	8mA/4.5mA (at 24 V DC/AC)
Definition:	X1...anode, X2...cathode

Additional Data

Mounting aperture:	16.2 mm
Tightening torque (mounting nut):	0.8 ... 1.5 Nm
Release:	twist release, left or right
Mounting position:	any
Standards:	EN 60947-5-1, EN 60947-5-5, EN ISO 13850
Material group:	I
Overvoltage category:	II
Pollution degree :	2

Electrical Features - 5µm gold-plating, type addition ...AU

Operational voltage:	20 mV...35 V AC/DC
Operational current AC/DC:	1mA ... 100mA
Ld:	20% (NC)
B10d:	250,000

Note

- with switching position indicator
- H= version with solder lug for hand soldering (YVOH..., YVOOH...)
- _674 ...with aluminium nut for plate thickness: 1.5...3.0 mm
torque - mounting nut: 1.2 Nm
- _RO ...0 ohm series resistor, with protective diode (series-connected)
- LED cut-off voltage: max. 75 V (incl. protective diode)
- If LED, max: 25 mA
- Uf LED, typical: 3.2 V (20mA)

- Use partially insulated Faston clamps (for versions with Faston terminals)
- Recommend Schlegel type "FHTI2,8x0,5_01"
- 0.5-1.5mm² (AWG 20-16)
- 30°C - 75°C

Note - applies to version "_RO" (0 ohm series resistor):
The LED must not be operated without series resistor.
Do not connect terminals X1-X2 directly to voltage. Observe LED data!

General Data

Type reference:	YVD(O)(OO)(_AU)_R0
Description:	Emergency-stop Head, active/inactive (without diagnostic device), LED without series resistor
Approvals:	CE, TÜV_Süd
Contact type:	1Ö / 2Ö
Degree of protection:	IP65 / IP67
Connection type:	Faston terminals 2.8 mm x 0.5 mm
Contact material:	AgNi / AgNi, gold-plated 5µm
Max. storage temperature:	-40°C ... 80°C
Max. operating temperature:	-25°C ... 55°C
Mechanical life:	30,000
Electrical life (rated load):	30,000 at rated load
Contact resistance NC:	< 20 mOhm / < 50 mOhm (Au)
Bouncing time NC:	< 10ms
Positive opening contact:	acc. to EN60947-5-1, appendix K

Electrical data acc. to IEC/EN 60947-5-1 (VDE 0660 Sect. 200)

	alternate current	direct current
Utilisation category:	AC15	DC13
Rated insulation voltage Ui:	250 V	250V
Rated operating voltage Ue:	35 V	35 V
Rated operating current Ie:	5A	2 A
Breaking capacity:	10Ie	1,1Ie
Continuous thermal current:	5A	

Technical Data - Lamp

Lamp socket:	none, with integrated 3 mm LED, without series resistor, with protective diode in series
Definition:	X1...anode, X2...cathode

Additional Data

Mounting aperture:	16.2 mm
Tightening torque (mounting nut):	0.8 ... 1.5 Nm
Release:	twist release, left or right
Mounting position:	any
Standards:	ISO 13850:2015(E), EN ISO 13850:2015(D), DIN EN ISO 13850:2016-05
Material group:	I
Overtoltage category:	II
Pollution degree :	2

Electrical Features - 5µm gold-plating, type addition _AU

Operational voltage:	20 mV...35 V AC/DC
Operational current AC/DC:	1mA ... 100mA
Ld:	20% (NC)
B10d:	250,000

Note

- Use partially insulated Faston clamps
 - Recommend Schlegel type "FHT12,8x0,5_01"
- 0.5-1.5mm² (AWG 20-16)
-30°C - 75°C

Technical Data of LED:

The LED must not be operated without series resistor.
Do not connect terminals X1-X2 directly to voltage. Observe LED data!

LED-Type:	(Datenblatt_LED_YVD_161220.pdf)
protective diode (series-connected):	Taiwan Semiconductor, TS4148 RYG, forward voltage max. 1.0V
LED series resistor:	0-Ohm

Typical data at IF=20mA, Tu=25°C: (=**recommended amperage**)

Safety Instructions:

- The emergency stop must only be used when lighting conditions ensure clear and distinct visibility of the red illuminated (active) mushroom,
e.g. in interiors or roofed places without direct sunlight (normal industrial environment).
- Before using the emergency stop, a systematic safety review of the overall system is required.
- Depending on the designer's risk assessment, the illumination of the emergency stop must be monitored by means of a "diagnostic unit", and in case of error one has to react in accordance with the risk evaluation.
- The emergency stop lighting must be checked at regular intervals to ensure its clear and distinct visibility.
The emergency stop must be replaced if the clear visibility is no longer guaranteed.
- Please observe the operation manual

Pushbutton Heads

Illustration	Dimensions	Description	Type
		<p>Pushbutton black, transparent lens</p> <p>Connection type Faston terminals 2.8 mm x 0.5 mm</p> <p>front bezel black</p> <p>push-cap white</p> <p>push-cap red</p> <p>push-cap green</p> <p>push-cap blue</p> <p>push-cap yellow</p>	<p>YTW</p> <p>YTR</p> <p>YTG</p> <p>YTB</p> <p>YTY</p>
		<p>Pushbutton silver-coloured, transparent lens</p> <p>Connection type Faston terminals 2.8 mm x 0.5 mm</p> <p>front bezel silver-coloured</p> <p>push-cap white</p> <p>push-cap red</p> <p>push-cap green</p> <p>push-cap blue</p> <p>push-cap yellow</p>	<p>YMTW</p> <p>YMTR</p> <p>YMTG</p> <p>YMTB</p> <p>YMTY</p>
		<p>Pushbutton with inscription, black</p> <p>standard imprints see nameplates from page 404 in the product catalogue (please specify index number), special inscription on request</p> <p>Connection type Faston terminals 2.8 mm x 0.5 mm</p> <p>front bezel black</p> <p>push-cap white</p>	<p>YTW_...</p>
		<p>Pushbutton with inscription, silver-coloured</p> <p>standard imprints see nameplates from page 404 in the product catalogue (please specify index number), special inscription on request</p> <p>Connection type Faston terminals 2.8 mm x 0.5 mm</p> <p>front bezel silver-coloured</p> <p>push-cap white</p>	<p>YMTW_...</p>

Pushbutton Heads

Illustration

Dimensions

Description

Type

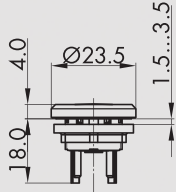

Illuminated pushbutton, black
incl. white LED

Connection type

Faston terminals 2.8 mm x 0.5 mm

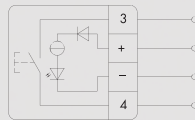

front bezel	black		
push-cap	white		YTLW
push-cap	red		YTLR
push-cap	green		YTLG
push-cap	blue		YTLB
push-cap	yellow		YTLY

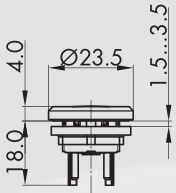

Illuminated Pushbutton, silver-coloured
incl. white LED

Connection type

Faston terminals 2.8 mm x 0.5 mm

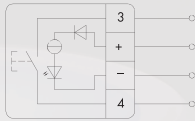

front bezel	silver-coloured		
push-cap	white		YMTLW
push-cap	red		YMTLR
push-cap	green		YMTLG
push-cap	blue		YMTLB
push-cap	yellow		YMTLY

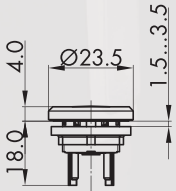

Illuminated Pushbutton with inscription, black
standard imprints see nameplates from page 404 in the product catalogue (please specify index number), special inscription on request
incl. white LED

Connection type

Faston terminals 2.8 mm x 0.5 mm

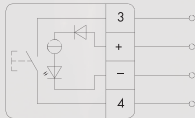

front bezel	black		
push-cap	white		YTLW_...
push-cap	red		YTLR_...
push-cap	green		YTLG_...
push-cap	blue		YTLB_...
push-cap	yellow		YTLY_...

About Us

Control Units

→ Actuators

Panel Mount Jacks

Bus Technology

RFID

Enclosures

Pedal/Limit Switches

Terminal Blocks

Type Index

Pushbutton Heads

Illustration

Dimensions

Description

Type

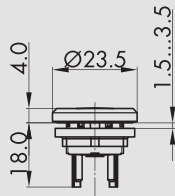

Illuminated Pushbutton with inscription, silver-coloured

standard imprints see nameplates from page 404 in the product catalogue (please specify index number), special inscription on request
incl. white LED

Connection type

Faston terminals 2.8 mm x 0.5 mm

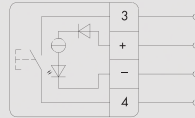

front bezel	silver-coloured		
push-cap	white		YMTLW_...
push-cap	red		YMTLR_...
push-cap	green		YMTLG_...
push-cap	blue		YMTLB_...
push-cap	yellow		YMTLY_...



Pushbutton black, non-transparent lens

Connection type

Faston terminals 2.8 mm x 0.5 mm

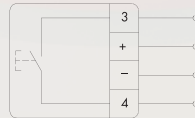

front bezel	black		
push-cap	white		YTGW
push-cap	red		YTGR
push-cap	green		YTTG
push-cap	blue		YTTB
push-cap	yellow		YTTY
push-cap	black		YTGS

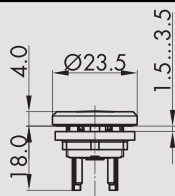

Pushbutton silver-coloured, non-transparent lens

Connection type

Faston terminals 2.8 mm x 0.5 mm

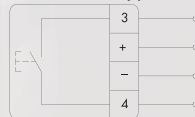

front bezel	silver-coloured		
push-cap	white		YMTGW
push-cap	red		YMTGR
push-cap	green		YMTGG
push-cap	blue		YMTGB
push-cap	yellow		YMTGY
push-cap	black		YMTGS

Emergency-Stop Head

type addition for gold-plated version _AU (e. g. YVOOL_AU)

Illustration

Dimensions

Description

Type

IP65
IP67

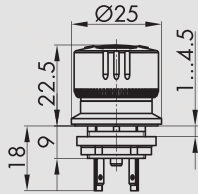

Active Illuminated Emergency-Stop with status indication active (illuminated) / inactive (non-illuminated)

- red illuminated emergency-stop (active) acc. to DIN EN ISO 13850:2016-05
- LED with 0-ohm resistor
- delivery without external LED monitoring
- less mounting depth
- 2 NC

Possible applications, e.g.:

- pluggable or wireless operator stations
- pluggable system components which are stationary available but only temporarily in operation

Not suitable for applications with direct sunlight.

Foolproof	Yes
Switching position indicator	Yes
Anti-lock collar	No
Release	twist right or left
Standard	ISO 13850:2015(E), EN ISO 13850:2015(D), DIN EN ISO 13850:2016-05
Connection type	Faston terminals 2.8 mm x 0.5 mm

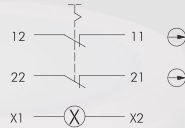

front bezel yellow
mushroom head red/grey



YV00_R0

IP65
IP67
IP69K

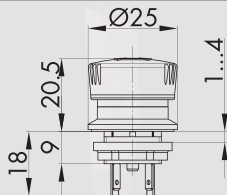

Emergency-Stop - 2NC

Foolproof	Yes
Switching position indicator	Yes
Anti-lock collar	No
Release	twist right or left
Standard	EN 60947-5-1, EN 60947-5-5, EN ISO 13850
Connection type	Faston terminals 2.8 mm x 0.5 mm

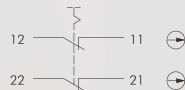

front bezel yellow
mushroom head red



YV00

About Us

Control Units
→ Actuators

Panel Mount Jacks

Bus Technology

RFID

Enclosures

Pedal/Limit Switches

Terminal Blocks

Type Index

Emergency-Stop Head

type addition for gold-plated version _AU (e. g. YVOOI_AU)

Illustration

Dimensions

Description

Type

IP65
IP67
IP69K

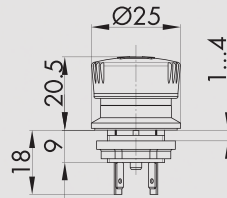

Emergency-Stop - 2NC+1NO

Foolproof	Yes
Switching position indicator	Yes
Anti-lock collar	No
Release	twist right or left
Standard	EN 60947-5-1, EN 60947-5-5, EN ISO 13850
Connection type	Faston terminals 2.8 mm x 0.5 mm

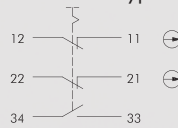

front bezel yellow
mushroom head red



YV001

IP65
IP67

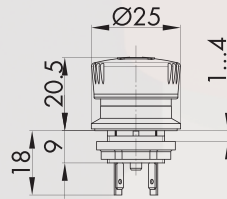

Illuminated Emergency-Stop - 1NC

Foolproof	Yes
Switching position indicator	Yes
Anti-lock collar	No
Release	twist right or left
Standard	EN 60947-5-1, EN 60947-5-5, EN ISO 13850
Connection type	Faston terminals 2.8 mm x 0.5 mm

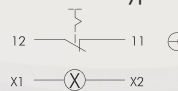

front bezel yellow
mushroom head red



YV10

IP65
IP67

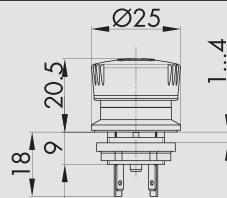

Illuminated Emergency-Stop - 2NC

Foolproof	Yes
Switching position indicator	Yes
Anti-lock collar	No
Release	twist right or left
Standard	EN 60947-5-1, EN 60947-5-5, EN ISO 13850
Connection type	Faston terminals 2.8 mm x 0.5 mm

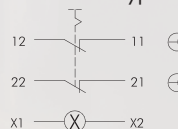

front bezel yellow
mushroom head red



YV100

Accessories for Contact blocks

Illustration

Dimensions

Description

Type



Faston Clamp 2.8 x 0.5, partially insulated, with snap-in pin

FHTI2,8x0,5_01

Cross section: 0.5-1.5mm²
 AWG: 20-16
 Material: brass, partially insulated, with snap-in pin
 Max. current: 10A
 Max. voltage: 300V
 Temperature: -30°C - 70°C
 UL Listed E70188

About Us

Control Units

→ Actuators

Panel Mount Jacks

Bus Technology

RFID

Enclosures

Pedal/Limit Switches

Terminal Blocks

Type Index



丸紅エレネクスト株式会社

Marubeni
Ele-Next



〒530-0003 大阪市北区堂島1丁目6番20号 TEL : 06-6344-2111 FAX : 06-6346-6611
URL : <https://www.m-elenext.co.jp>

特殊部品カンパニー

新横浜支店 (045-474-9524) ・名古屋支店 (052-201-7071) ・大阪支店 (06-7656-3690)

事業所

仙台支店・関東支店 川越オフィス・関東支店 新横浜オフィス・浜松支店・名古屋支店・北陸出張所 (富山)

京滋支店 (京都) ・大阪支店・姫路支店・四国支店 (高松) ・九州支店 (福岡)



Georg Schlegel GmbH & Co. KG
Kapellenweg 4
88525 Dürmentingen / Germany

☎ +49 (0)7371 / 502-0
📠 +49 (0)7371 / 502 49
@ info@schlegel.biz
www.schlegel.biz



Subsidiaries:

Schlegel Elektrokontakt GmbH
Schönbachstr. 93
04299 Leipzig / Germany

☎ +49 (0)341 / 8 68 72-0
📠 +49 (0)341 / 8 68 72 43
@ leipzig@schlegel.biz
www.schlegel.biz

Georg Schlegel Vertriebs Ges.mbH
Samuel Morse-Straße 7
2700 Wiener Neustadt / Austria

☎ +43 (0)2622 / 81313
📠 +43 (0)2622 / 8 13 13-19
@ schlegel@schlegel.at
www.schlegel.at